



Raccord de freinage Hydraulique et pneumatique

Chapitre 6

2025

CIFLUID
Votre expert hydraulique

Sommaire

01- TUBE RILSAN	-----	04-05
02- FREINAGE PNEUMATIQUE	-----	06-45
03- FREINAGE HYDRAULIQUE	-----	46-55
04- ACCESSOIRES POIDS LOURD	-----	56-58



1- TUBE RILSAN



Tube polyamide noir en rouleau



Tube polyamide noir en rouleau

Tube polyamide noir en rouleau de 25 ou 30 mètres
Selon norme DIN

Code	Référence	Diamètre ext en pouce	Diamètre int	Diamètre ext	Pression de service	Pression d'éclatement	Poids
COURONNE 25M							
010623	RILSAN DIN 2X4 25M		2mm	4mm			0
079346	RILSAN DIN 2,3X4 25M		2.3mm	4.25mm			0
010624	RILSAN DIN 3X5 25M		3mm	5mm			0
010625	RILSAN DIN 3X6 25M		3mm	6mm			0
010626	RILSAN DIN 4X6 25M		4mm	6mm			0
010627	RILSAN DIN 5X8 25M		5mm	8mm			0
010628	RILSAN DIN 6X8 25M		6mm	8mm			0
030984	RILSAN DIN 6X9 25M		6mm	9mm			0
014523	RILSAN DIN 7X10 25M		7mm	10mm			0
010629	RILSAN DIN 8X10 25M		8mm	10mm			0
010630	RILSAN DIN 8X11 25M		8mm	11mm			0
010631	RILSAN DIN 8X12 25M		8mm	12mm			0
010632	RILSAN DIN 9X12 25M		9mm	12mm			0
014524	RILSAN DIN 10X12 25M		10mm	12mm			0
081626	RILSAN DIN 10X12.5 25M		10mm	12.5mm			0
010633	RILSAN DIN 10X14 25M		10mm	14mm			0
010634	RILSAN DIN 12X15 25M		12mm	15mm			0
010635	RILSAN DIN 12X16 25M		12mm	16mm			0
104157	RILSAN DIN 12X18 25M		12mm	18mm			0
010636	RILSAN DIN 14X18 25M		14mm	18mm			0
COURONNE 30M							
030368	RILSAN DIN 3/16 (4.76) 30M			4.76mm			0
030370	RILSAN DIN 3/8 (9.52) 30M			9.52mm			0
030367	RILSAN DIN 1/8 (3.175) 30M			3.175mm			0
030369	RILSAN DIN 1/4 (6.35) 30M			6.35mm			0
030371	RILSAN DIN 1/2 (12.7) 30M			12.7mm			0
030372	RILSAN DIN 5/8 (15.875) 30M			15.875mm			0

2- FREINAGE PNEUMATIQUE



Union double laiton freinage



Union double laiton freinage

Utilisation : Freinage pneumatique

Matière: laiton

Type: Système P5

Code	Référence	D1	D2	D3	Poids
RA6237195	RPF UD04X1.0	4X1.0	4X1.0		0.046
RA6237205	RPF UD06X1.0	6X1.0	6X1.0		0.046
RA6237225	RPF UD08X1.0	8X1.0	8X1.0		0.055
RA6237305	RPF UD10X1.0	10X1.0	10X1.0		0.069
RA6237315	RPF UD10X1.25	10X1.25	10X1.25		0.08
RA6237325	RPF UD10X1.5	10X1.5	10X1.5		0.081
RA6237355	RPF UD11X1.5	11X1.5	11X1.5		0.71
RA6237365	RPF UD12X1.5	12X1.5	12X1.5		0.081
RA6237445	RPF UD15X1.5	15X1.5	15X1.5		0.158
RA6237465	RPF UD16X2.0	16X2.0	16X2.0		0.136
RA6237475	RPF UD18X2.0	18X2.0	18X2.0		0.151
RA6237115	RPF UD1/4	1/4"	1/4"		0.036
RA6237135	RPF UD3/8	3/8"	3/8"		0.067
RA6237155	RPF UD1/2	1/2"	1/2"		0
RA6237175	RPF UD5/8	5/8"	5/8"		0.1

Union male laiton freinage



Union male laiton freinage

Utilisation : Freinage pneumatique

Matière: laiton

Type: Système P5

Code	Référence	D1	D2	D3	Poids
RA6237185	RPF UM04X1.0X1/8-27NPTF	4X1	1/8" NPT		0
RA6237190	RPF UM04X1.0XM10X100	4X1	M10X100		0.019
RA6237192	RPF UM04X1.0XM12X150	4X1	M12X150		0.022
RA6237197	RPF UM04X1.0XM22X150	4X1	M22X150		0
RA6237201	RPF UM06X1.0X1/8-27NPTF	6X1	1/8" NPT		0
RA6237203	RPF UM06X1.0X1/4-18NPTF	6X1	1/4" NPT		0
RA6237210	RPF UM06X1.0XM10X100	6X1	M10X100		0
RA6237212	RPF UM06X1.0XM12X150	6X1	M12X150		0.046
RA6237214	RPF UM06X1.0XM14X150	6X1	M14X150		0
RA6237216	RPF UM06X1.0XM16X150	6X1	M16X150		0.05
RA6237217	RPF UM06X1.0XM22X150	6X1	M22X150		0.057
RA6237223	RPF UM08X1.0X1/4-18NPTF	8X1	1/4" NPT		0
RA6237233	RPF UM08X1.0X3/8-18NPTF	8X1	3/8" NPT		0
RA6237230	RPF UM08X1.0XM10X100	8X1	M10X100		0
RA6237232	RPF UM08X1.0XM12X150	8X1	M12X150		0.035
RA6237234	RPF UM08X1.0XM14X150	8X1	M14X150		0.04
RA6237236	RPF UM08X1.0XM16X150	8X1	M16X150		0.044
RA6237237	RPF UM08X1.0XM22X150	8X1	M22X150		0.062
RA6237262	RPF UM09X1.5XM12X150	9X1.5	M12X150		0
RA6237300	RPF UM10X1.0XM10X100	10X1	M10X100		0
RA6237302	RPF UM10X1.0XM12X150	10X1	M12X150		0
RA6237304	RPF UM10X1.0XM14X150	10X1	M14X150		0
RA6237306	RPF UM10X1.0XM16X150	10X1	M16X150		0.052
RA6237307	RPF UM10X1.0XM22X150	10X1	M22X150		0.067
RA6237312	RPF UM10X1.25XM12X150	10X1.25	M12X150		0
RA6237314	RPF UM10X1.25XM14X150	10X1.25	M14X150		0
RA6237316	RPF UM10X1.25XM16X150	10X1.25	M16X150		0
RA6237317	RPF UM10X1.25XM22X150	10X1.25	M22X150		0
RA6237323	RPF UM10X1.5X1/4-18NPTF	10X1.5	1/4 NPT		0
RA6237330	RPF UM10X1.5XM10X100	10X1.5	M10X100		0
RA6237332	RPF UM10X1.5XM12X150	10X1.5	M12X150		0.046
RA6237334	RPF UM10X1.5XM14X150	10X1.5	M14X150		0
RA6237336	RPF UM10X1.5XM16X150	10X1.5	M16X150		0
RA6237337	RPF UM10X1.5XM22X150	10X1.5	M22X150		0
RA6237356	RPF UM11X1.5XM16X150	11X1.5	M16X150		0
RA6237363	RPF UM12X1.5X1/4-18NPTF	12X1.5	1/4 NPT		0

Code	Référence	D1	D2	D3	Poids
RA6237370	RPF UM12X1.5XM10X100	12X1.5	M10X100		0
RA6237372	RPF UM12X1.5XM12X150	12X1.5	M12X150		0
RA6237374	RPF UM12X1.5XM14X150	12X1.5	M14X150		0.053
RA6237376	RPF UM12X1.5XM16X150	12X1.5	M16X150		0
RA6237377	RPF UM12X1.5XM22X150	12X1.5	M22X150		0
RA6237444	RPF UM15X1.5XM14X150	15X1.5	M14X150		0
RA6237446	RPF UM15X1.5XM16X150	15X1.5	M16X150		0
RA6237448	RPF UM15X2.0XM16X150	15X2	M16X150		0
RA6237447	RPF UM15X1.5XM22X150	15X1.5	M22X150		0
RA6237451	RPF UM15X1.5XM26X150	15X1.5	M26X150		0
RA6237449	RPF UM15X2.0XM22X150	15X2	M22X150		0
RA6237452	RPF UM16X2.0XM12X150	16X2.0	M12X150		0
RA6237454	RPF UM16X2.0XM14X150	16X2.0	M14X150		0
RA6237456	RPF UM16X2.0XM16X150	16X2.0	M16X150		0
RA6237457	RPF UM16X2.0XM22X150	16X2.0	M22X150		0
RA6237468	RPF UM16X2.0XM26X150	16X2.0	M26X150		0
RA6237476	RPF UM18X2.0XM16X150	18X2.0	M16X150		0
RA6237477	RPF UM18X2.0XM22X150	18X2.0	M22X150		0
RA6237478	RPF UM18X2.0XM26X150	18X2.0	M26X150		0
RA6237124	RPF UM3/8X3/8-18NPTF	3/8	18 NPT		0
RA6237125	RPF UM3/8X1/2-14NPTF	3/8	1/2 NPT		0
RA6237144	RPF UM1/2X3/8-18NPTF	1/2	3/8 NPT		0
RA6237145	RPF UM1/2X1/2-14NPTF	1/2	1/2 NPT		0
RA6237165	RPF UM5/8X1/2-14NPTF	5/8	1/2 NPT		0
RA6237112	RPF UM1/4XM12X150	1/4"	M12X150		0
RA6237114	RPF UM1/4XM14X150	1/4"	M14X150		0
RA6237116	RPF UM1/4XM16X150	1/4"	M16X150		0
RA6237132	RPF UM3/8XM12X150	3/8"	M12X150		0
RA6237134	RPF UM3/8XM14X150	3/8"	M14X150		0
RA6237136	RPF UM3/8XM16X150	3/8"	M16X150		0
RA6237152	RPF UM1/2XM12X150	1/2"	M12X150		0
RA6237156	RPF UM1/2XM16X150	1/2"	M16X150		0
RA6237176	RPF UM5/8XM16X150	5/8"	M16X150		0
RA6237177	RPF UM5/8XM22X150	5/8"	M22X150		0

Union male passe cloison freinage

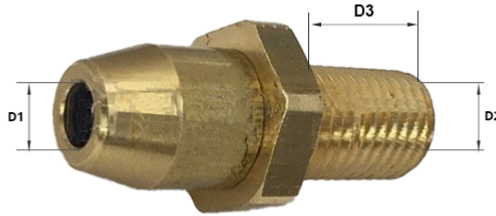

Union male passe cloison freinage

Utilisation : Freinage pneumatique

Matière: laiton

Type: Système P5

Code	Référence	D1	D2	D3	Poids
RA6237202	RPF UM06X1.0XM12X150/24°-06LCLL20	6X1	06L-M12X1.5	20mm	0
RA6237246	RPF UM08X1.0XM16X150/M10X100CLL20	8X1	M16X150	20mm	0

Coude 90° (et 45°) taraudage freinage

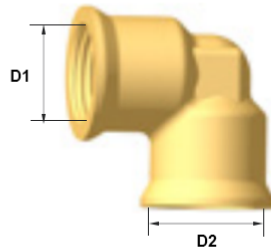

Coude 90° (et 45°) taraudage freinage

Utilisation : Freinage pneumatique

Matière: laiton

Type: Système P5

Code	Référence	D1	D2	D3	Poids
COUDE 90°					
RA6236803	RPF CF12X150XP590°	M12X150	P5		0
RA6236833	RPF CF16X150XP590°	M16X150	P5		0
COUDE 45°					
RA6236832	RPF CF16X150XP545°	M16X150	P5		0

Coude 90° 2 taraudages freinage

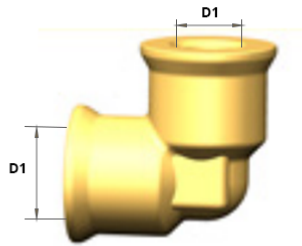

Coude 90° 2 taraudages freinage

Utilisation : Freinage pneumatique

Matière: laiton

Type: Système P5

Code	Référence	D1	D2	D3	Poids
RA6237823	RPF CT12X150X12X150	M12X150	M12X150		0
RA6237862	RPF CT16X150X16X150	M16X150	M16X150		0
RA6237865	RPF CT18X150X16X150	M18X150	M16X150		0
RA6237867	RPF CT22X150X22X150	M22X150	M22X150		0

CoUDE 90° male x femelle passe cloison freinage



CoUDE 90° male x femelle passe cloison freinage

Utilisation : Freinage pneumatique

Matière: laiton

Type: Système P5

Code	Référence	D1	D2	D3	Poids
RA6237807	RPF ACM12X150XF12X150CLL18	M12X150	12X150		0.045
RA6237813	RPF ACM14X150XF12X150CLL22	M14X150	12X150		0.048
RA6237872	RPF ACM18X150/24°-12LXF16X150CLL34	M18X150	16X150		0
RA6237871	RPF ACM27X150XF27X150CLL25	M27X150	27X150		0

Coude 90° male x male passe cloison freinage



Coude 90° male x male passe cloison freinage

Utilisation : Freinage pneumatique

Matière: laiton

Type: Système P5

Code	Référence	D1	D2	D3	Poids
RA6237810	RPF ACM12X150XM16X150/24°-10LCLL17	M12X150	M16X150		0
RA6237866	RPF ACM22X150/F16X150XM18X150/24°-12	M22X150	M18X150		0
RA6237880	RPF ACM22X150/F16X150XM22X150CLL22	M22X150	M22X150		0.19
RA6237882	RPF ACM22X150/F16X150XM22X150CLL20	M22X150	M22X150		

Coude 45° male x femelle passe cloison freinage

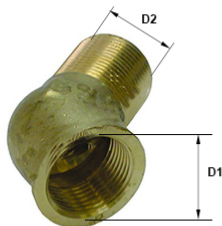

Coude 45° male x femelle passe cloison freinage

Matière: laiton
Type: Système P5

Code	Référence	D1	D2	D3	Poids
RA6237873	RPF AYM16X150XF16X150CLL25	M16X150	16X150		0.088
RA6237881	RPF AYM22X150/F16X150XF22X150CLL23	M22X150	16X150		0

Croix symétrique - taraudages M16x1,5

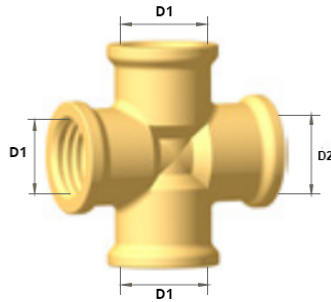

Croix symétrique - taraudages M16x1,5

Utilisation : Freinage pneumatique

Matière: laiton

Type: Système P5

Code	Référence	D1	D2	D3	Poids
RA6236838	RPF CXE16X150XP5	M16X150	P5		0

Croix renversée sur 2 plans - Taraudages M16x1,5

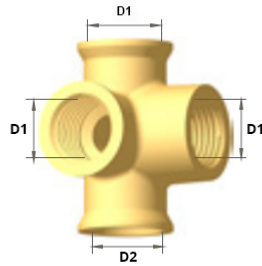

Croix renversée sur 2 plans - Taraudages M16x1,5

Utilisation : Freinage pneumatique

Matière: laiton

Type: Système P5

Code	Référence	D1	D2	D3	Poids
RA6236839	RPF CXL16X150XP5	M16X150	P5		0

Croix 4 taraudages freinage

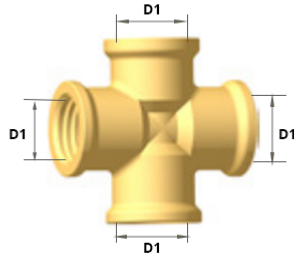

Croix 4 taraudages freinage

Matière: laiton
Type: Système P5

Code	Référence	D1	D2	D3	Poids
RA6237827	RPF CXT12X150X12X150	M12X150			0
RA6237828	RPF CXT16X150X16X150	M16X150			0

Croix sur 2 plans - Tauraudages M16x1,5

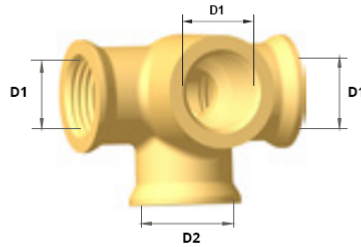

Croix sur 2 plans - Tauraudages M16x1,5

Utilisation : Freinage pneumatique

Matière: laiton

Type: Système P5

Code	Référence	D1	D2	D3	Poids
RA6236837	RPF CXT16X150XP5	M16X150	P5		0

Adapteur male x femelle freinage

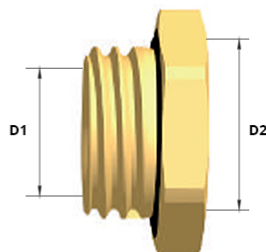

Adapteur male x femelle freinage

Utilisation : Freinage pneumatique

Matière: laiton

Type: Système P5

Code	Référence	D1	D2	D3	Poids
RA6237655	RPF ADM16X150XF1/8-27NPTF	M16X150	1/8 NPTF		0
RA6237656	RPF ADM16X150XF1/4-18NPTF	M16X150	1/4 NPTF		
RA6237657	RPF ADM16X150XF3/8-18NPTF	M16X150	3/8 NPTF		0
RA6237626	RPF ADM1/4-18NPTFXF12X150	1/4"	12X150		0
RA6237628	RPF ADM1/4-18NPTFXF16X150	1/4"	16X150		0
RA6237633	RPF ADM3/8-18NPTFXF16X150	3/8"	16X150		0

Adaptateur reducteur de débit freinage

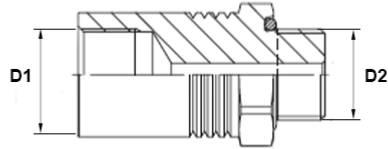

Adaptateur reducteur de débit freinage

Utilisation : Freinage pneumatique

Matière: laiton

Type: Système P5

Code	Référence	D1	D2	D3	Poids
RA6237661	RPF ADM16X150XF16X150REDUIT3.0	M16X150	16X150		0
RA6237662	RPF ADM16X150XF16X150REDUIT2.5	M16X150	16X150		0
RA6237692	RPF ADM16X150XF16X150REDUIT10	M16X150	16X150		0

Adaptateur droit male x femelle passe cloison freinage

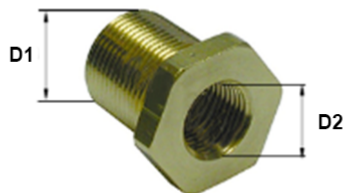

Adaptateur droit male x femelle passe cloison freinage

Utilisation : Freinage pneumatique

Matière: laiton

Type: Système P5

Code	Référence	D1	D2	D3	Poids
RA6161182	RPF ADM16X150XF10X100CLL28	M16X150	10X100		0
RA6237614	RPF ADM16X150XF12X150	M16X150	12X150		0
RA6237622	RPF ADM12X150XM12X150CLL24	M12X150	M12X150		0.029
RA6237722	RPF ADM16X150XF10X100CLL20	M16X150	10X100		0.035
RA6239113	RPF ADM12X150/24°-06LXF12X150CLL34	M12X150	12X150		0
RA6237727	RPF ADM26X150XF16X150CLL24	M16X150	16X150		0.1
RA6237728	RPF ADM22X150/F16X150X3/8-18NPTCLL24	M22X150	16X150		0
RA6237729	RPF ADM22X150/F16X150X1/2-14NPTCLL24	M22X150	16X150		0
RA6237726	RPF ADM22X150XF16X150CLL24	M22X150	16X150		0.056
RA6237731	RPF ADM22X150/F16X150XM16X150CLL24	M22X150	M16X150		0.076
RA6237733	RPF ADM22X150/F16X150XM16X150CLL40	M22X150	M16X150		0
RA6237735	RPF ADM22X150XM16X150CLL24	M22X150	M16X150		0.076
CONE 24°					
RA6237696	RPF ADM16X150/24°-10LXM22X150/F16X	M16X150	22X150		0.07
RA6237725	RPF ADM18X150/24°-12LXF16X150CLL45	M18X150	16X150		0
RA6237732	RPF ADM18X150/24°-12LXF16X150CLL34	M18X150	16X150		0.06

Adapteur droite male x male passe cloison freinage

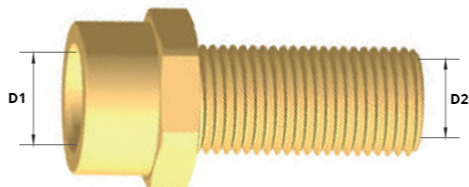

Adapteur droite male x male passe cloison freinage

Utilisation : Freinage pneumatique

Matière: laiton

Type: Système P5

Code	Référence	D1	D2	D3	Poids
RA6237624	RPF ADM14X150XM12X150CLL24	M14X150	12X150		0
RA6237723	RPF ADM16X150XF10X100CLL35	M16X150	10X100		0
RA6237695	RPF ADM16X150/24°-10LXF16X150CLL34	M16X150	16X150		0.076
RA6237697	RPF ADM16X150XM16X150CLL35	M16X150	16X150		0.075
RA6237694	RPF ADM22X150/24°-15LXF16X150CLL24	M22X150	16X150		0
RA6237721	RPF ADM22X150/F16X150XM22X150CLL40	M22X150	22X150		0

Adapteur male x male freinage

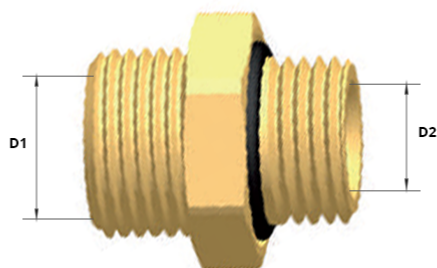

Adapteur male x male freinage

Utilisation : Freinage pneumatique

Matière: laiton

Type: Système P5

Code	Référence	D1	D2	D3	Poids
RA6237781	RPF ADM10X100XM12X150/24°-06L	M10X100	M12X150		0
RA6237782	RPF ADM16X150XM12X150/24°-06L	M16X150	M12X150		0
RA6237783	RPF ADM12X150XM16X150/24°-10L	M12X150	M16X150		0
RA6237784	RPF ADM16X150XM16X150/24°-10L	M16X150	M16X150		0
RA6237785	RPF ADM16X150XM18X150/24°-12L	M16X150	M18X150		0
RA6126278	RPF ADM22X150XM22X150/24°-15L	M22X150	M22X150		0

Te symétrique taraudages freinage

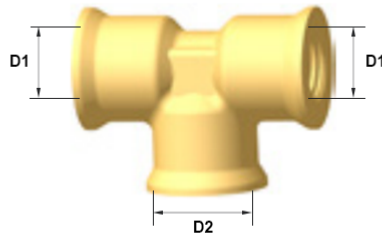

Te symétrique taraudages freinage

Utilisation : Freinage pneumatique

Matière: laiton

Type: Système P5

Code	Référence	D1	D2	D3	Poids
RA6236805	RPF TE12X150XP5	M12X150	P5		0
RA6236835	RPF TE16X150XP5	M16X150	P5		0

Te renservé - 2 taraudages freinage

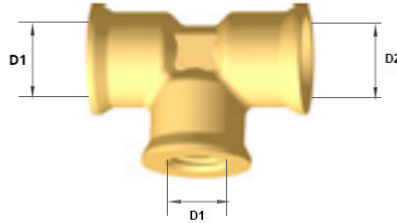

Te renservé - 2 taraudages freinage

Utilisation : Freinage pneumatique

Matière: laiton

Type: Système P5

Code	Référence	D1	D2	D3	Poids
RA6236804	RPF TL12X150XP5	M12X150	P5		0
RA6236834	RPF TL16X150XP5	M16X150	P5		0

Te sur 2 plans - taraudages M16X1,5

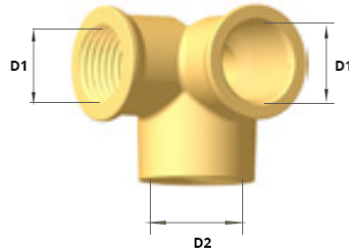

Te sur 2 plans - taraudages M16x1,5

Utilisation : Freinage pneumatique

Matière: laiton

Type: Système P5

Code	Référence	D1	D2	D3	Poids
RA6236846	RPF YE16X150XP5	M16X150	P5		0

Te 3 taraudages freinage

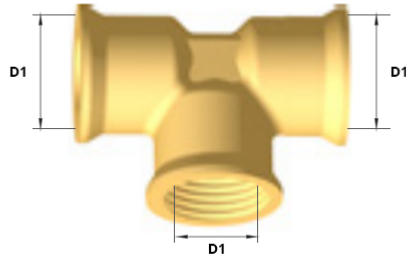

Te 3 taraudages freinage

Utilisation : Freinage pneumatique

Matière: laiton

Type: renfort système P5

Code	Référence	D1	D2	D3	Poids
RA6237825	RPF TT12X150X12X150	M12X150			0
RA6237864	RPF TT16X150X16X150	M16X150			0
RA6237868	RPF TT22X150X22X150	M22X150			0

Te taraude avec fixation freinage



TEF



T9F



T4F

Te taraude avec fixation freinage

Matière: laiton
Type: Système P5

Code	Référence	D1	D2	D3	Poids
RA6237863	RPF TEF12X150X16X150	12X150	16X150		0
RA6126913	RPF T4F16X150X16X150	16X150	16X150		0
RA6126935	RPF T9F16X150X16X150	16X150	16X150		0

Te male renverse passe cloison freinage

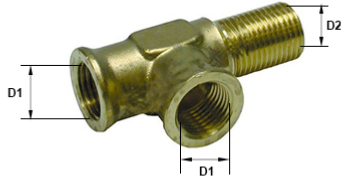

Te male renverse passe cloison freinage

Utilisation : Freinage pneumatique

Matière: laiton

Type: Système P5

Code	Référence	D1	D2	D3	Poids
RA6237816	RPF ATMRM16X150XF16X150CLL20	M16X150	16X150		0
RA6237875	RPF ATMRM22X150/F16X150XF16X150CLL20	M22X150	16X150		0

Te male passe cloison freinage

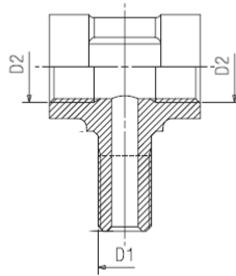

Te male passe cloison freinage

Utilisation : Freinage pneumatique

Matière: laiton

Type: Système P5

Code	Référence	D1	D2	D3	Poids
RA6162895	RPF ATMM12X150XF16X150CLL21	M12X150	16X150		0
RA6161895	RPF ATMM16X150XF16X150CLL21	M16X150	16X150		0

Coude spécial pour embase P5 freinage

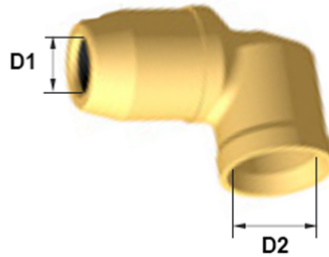

Coude spécial pour embase P5 freinage

Utilisation : Freinage pneumatique

Matière: laiton

Type: Système P5

Code	Référence	D1	D2	D3	Poids
RA6236816	RPF CO06X1.0XP5	6x1	P5		0
RA6236826	RPF CO08X1.0XP5	8X1	P5		0
RA6236814	RPF CO10X1.25XP5	10X1.25	P5		0
RA6236991	RPF CO10X1.0XP5	10X1	P5		0
RA6236824	RPF CO10X1.5XP5	10X1.5	P5		0
RA6236836	RPF CO12X1.5XP5	12X1.5	P5		0
RA6236992	RPF CO15X1.5XP5	15X1.5	P5		0
RA6236993	RPF CO15X2.0XP5	15X2	P5		0
RA6236840	RPF CO16X2.0XP5	16x1.5	P5		0

Te male 90° passe cloison freinage

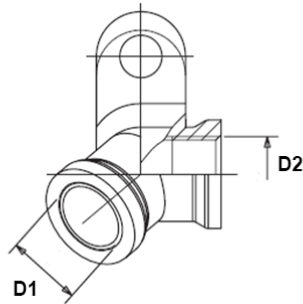

Te male 90° passe cloison freinage

Utilisation : Freinage pneumatique

Matière: laiton

Type: Système P5

Code	Référence	D1	D2	D3	Poids
RA6161896	RPF ATM9M10X100XF12X150CLL18	M10X100	12X150		0
RA6161897	RPF ATM9M12X150XF12X150CLL18	M12X150	12X150		0
RA6161898	RPF ATM9M14X150XF12X150CLL21	M14X150	12X150		0
RA6161899	RPF ATM9M16X150XF16X150CLL21	M16X150	16X150		0

Coude taraude avec fixation freinage

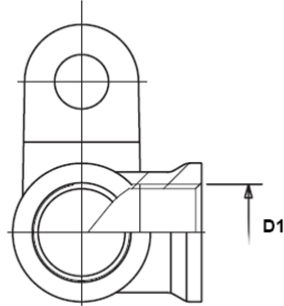

Coude taraude avec fixation freinage

Utilisation : Freinage pneumatique

Matière: laiton

Type: Système P5

Code	Référence	D1	D2	D3	Poids
		45°			
RA6126903	RPF CFT16X150X16X15045°	M16X150	M16X150		0
		90°			
RA6126934	RPF CFT16X150X16X15090°	M16X150	M16X150		0

Embase laiton P5 freinage



Embase P5 freinage

Utilisation : Freinage pneumatique

Matière: laiton

Type: Système P5

Code	Référence	D1	D2	D3	Poids
RA6237010	RPF P5XM10X100	P5	M10X100		0.022
RA6237012	RPF P5XM12X150	P5	M12X150		0.024
RA6237014	RPF P5XM14X150	P5	M14X150		0.025
RA6237016	RPF P5XM16X150	P5	M16X150		0.036
RA6237017	RPF P5XM22X150	P5	M22X150		0.051
RA6237019	RPF P5XM26X150	P5	M26X150		0
RA6237021	RPF P5XMG1/4R	P5	1/4"		0.043
RA6237026	RPF P5XMG3/8R	P5	3/8"		0.039
RA6237031	RPF P5X1/8-27NPTF	P5	1/8" NPTF		0.028
RA6237032	RPF P5X1/4-18NPTF	P5	1/4" NPTF		0
RA6237033	RPF P5X3/8-18NPTF	P5	3/8" NPTF		0.038
RA6037034	RPF P5X1/2-14NPTF	P5	1/2" NPTF		0

Vis de purge pour bouteille freinage

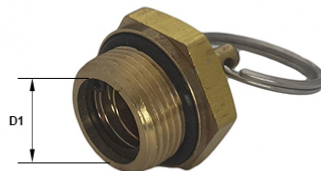

Vis de purge pour bouteille freinage

Utilisation : Freinage pneumatique

Matière: laiton

Type: Système P5

Code	Référence	D1	D2	D3	Poids
RA6237787	RPF VIS DE PURGE M22X150	M22X150			0.044

Contre écrou freinage

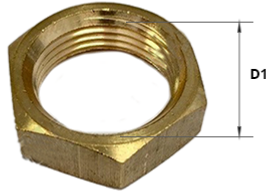

Contre écrou freinage

Utilisation : Freinage pneumatique

Matière: laiton

Type: Système P5

Code	Référence	D1	D2	D3	Poids
RA6237748	RPF CCE16X150LAITON	16X150			0
RA6237775	RPF CCE18X150LAITON	18X150			0
RA6237749	RPF CCE22X150LAITON	22X150			0

Joint torique pour contre écrou freinage



Joint torique pour contre écrou freinage

Utilisation : Freinage pneumatique

Matière: laiton

Type: Système P5

Code	Référence	D1	D2	D3	Poids
RA3579119	RPF JTCE12X150	12X150			0.013
RA3579094	RPF JTCE14X150	14X150			0.028
RA3579092	RPF JTCE16X150	16X150			0.028
RA3579219	RPF JTCE18X150	18X150			0.029
RA3579086	RPF JTCE22X150	22X150			0.047

Bouchon male freinage

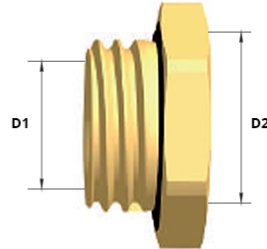

Bouchon male freinage

Matière: laiton
Type: Système P5

Code	Référence	D1	D2	D3	Poids
RA6237605	RPF ABM12X150	12X150			0
RA6237606	RPF ABM14X150	14X150			0
RA6237607	RPF ABM16X150	16X150			0
RA6237608	RPF ABM22X150	22X150			0

Nipple male avec joint incorpore freinage

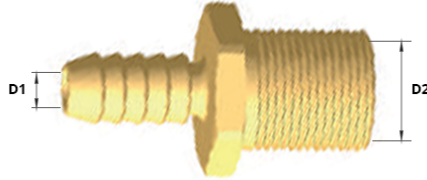

Nipple male avec joint incorpore freinage

Utilisation : Freinage pneumatique

Matière: laiton

Type: Système P5

Code	Référence	D1	D2	D3	Poids
RA6237926	RPF D09.5XM16X150	9.5	M16X150		0
RA6237927	RPF D09.5XM22X150	9.5	M22X150		0
RA6237752	RPF D09.5XM22X150/F16X150	9.5	M22X150		
RA6237905	RPF D10.0XM16X150	10	M16X150		0.043
RA6237912	RPF D10.0XM22X150	10	M22X150		0.072
RA6237906	RPF D11.0XM12X150	11	M12X150		0
RA6237907	RPF D11.0XM16X150	11	M16X150		0.043
RA6237915	RPF D11.0XM22X150	11	M22X150		0
RA6237908	RPF D13.0XM16X150	13	M16X150		0
RA6237914	RPF D13.0XM22X150	13	M22X150		0
RA6237911	RPF D14.5XM16X150	14.5	M16X150		0.046
RA6237913	RPF D14.5XM22X150	14.5	M22X150		0.073

Prise de pression ISO 3583 freinage

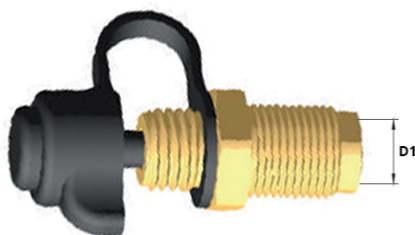

Prise de pression ISO 3583 freinage

Utilisation : Freinage pneumatique

Matière: laiton

Type: Système P5

Code	Référence	D1	D2	D3	Poids
RA6239144	RPF PP16X150XM18X150/F12X150CLL18	16X150	12X150		0.06
RA6237776	RPF PP16X150XM16X150	16X150	M16X150		0.05
RA6237207	RPF PP16X150XM18X150/F06X100CLL18	16X150	M18X150		0
RA6237777	RPF PP16X150XM22X150	16X150	M22X150		0.066
RA3579076	RPF PP16X150CAPUCHON	16X150			0.01

Têtes d'accouplements freinage



Têtes d'accouplements freinage

Utilisation : Freinage pneumatique

Matière: acier

Type: Système P5

Code	Référence	D1	D2	D3	Poids
RA674204	RPF TETEREMORQUE16X150JAUNE	16X150			0.205
RA674205	RPF TETEREMORQUE16X150ROUGE	16X150			0.202
RA674206	RPF TETEREMORQUE16X150JAUNEPP	16X150			0
RA674210	RPF TETRACTEUR16X150JAUNE	16X150			0.226
RA674211	RPF TETRACTEUR16X150ROUGE	16X150			0.216

Serpentins freinage



Serpentins freinage

Matière: laiton
Type: Système P5

Code	Référence	D1	D2	D3	Poids
043386	RPF SERPENTIN M16X150 ROUGE LG 4M	M16X150			0.58
043387	RPF SERPENTIN M16X150 JAUNE LG 4M	M16X150			0.58
043388	RPF SERP M16X150 F18X150 L4M NOIR	M16X150	18X150		0.5
108629	RPF SERPENTIN M16X150 ROUGE LG 14M	M16X150			1.34

Coffret raccords de freinage pneumatique



Coffret raccords de freinage pneumatique

Matière: laiton
Type: Système P5

Code	Référence	D1	D2	D3	Poids
RA260096	COFFRET RACCORDS DE FREINAGE PNEUMAT				0

Bloc de distribution freinage



Bloc de distribution freinage

Utilisation : Freinage pneumatique

Matière: laiton

Type: Système P5

Code	Référence	D1	D2	D3	Poids
RA6237765	RPF BR2X4F16X150XF16X150	16X150	4 SORTIES		0
RA6237767	RPF BR2X6F16X150XF12X150	16X150	6 SORTIES		0

3 - FREINAGE HYDRAULIQUE



Tube frein cuivre



Tube frein cuivre

Utilisation : freinage hydraulique
Matière : Cuivre
Norme : SAE J527 - BS2871 - ASTM A254
D2 : Pression de service
D3 : Pression d'éclatement

Code	Référence	D1	D2	D3	Poids
COURONNE 50M					
098503	TUBE FREIN CUIVRE 4,75X0,9 50M	4.75X0.9	258	774	0.1
COURONNE 25M					
078479	TUBE FREIN CUIVRE 5X0,9 25M	5x0.9	167	501	0.106
COURONNE 10M					
030274	TUBE FREIN CUIVRE 3,5X0,9 10M	3.5X0.9	349	1047	0.066
030275	TUBE FREIN CUIVRE 4,5X0,9 10M	4.5X0.9	272	816	0.094
030255	TUBE FREIN CUIVRE 4,75X0,9 10M	4.75X0.9	258	774	0.1
030277	TUBE FREIN CUIVRE 6X0,9 10M	6X0.9	197	591	0.116
030278	TUBE FREIN CUIVRE 6,35X0,8 10M	6.35X0.9	184	552	0.152
030279	TUBE FREIN CUIVRE 8X0,9 10M	8X0.9	143	429	0.164
COURONNE 7M					
110920	TUBE FREIN CUIVRE 4,0X1,0 7.5M	4X1	258	774	0.071
COURONNE 5M					
030276	TUBE FREIN CUIVRE 5X1 5M	5X1	167	501	0.104
078481	TUBE FREIN CUIVRE 5X0,9 5M	5X0.9	167	501	0.104

Tube frein zingué



Tube frein zingué

Utilisation : freinage pneumatique

Matière : acier

Norme : DIN 74234

D2 : pression service

D3 : pression d'éclatement

Code	Référence	D1	D2	D3	Poids
030280	TUBE FREIN ACIER 4,76X0,7 32M	4.76X0.7	290	881	0.07
030281	TUBE FREIN ACIER 6X0,7 32M	6X0.7	230	705	0.09
030282	TUBE FREIN ACIER 6,35X0,7 32M	6.35X0.7	220	660	0.098
030283	TUBE FREIN ACIER 8X0,7 32M	8X0.7	175	528	0.125

Raccord frein evase



Raccord frein evase

Utilisation : freinage hydraulique

Matière: acier

Type: Système P5

Code	Référence	D1	D2	D3	Poids
043507	RACCORD FREIN EVASE 4.76X1/2-20UNF	4.76	1/2-20UNF		0
043515	RACCORD FREIN EVASE 6X1/2-20UNF	6	1/2-20UNF		0.009
043516	RACCORD FREIN EVASE 6XM12X100	6	M12X100		0.011
043517	RACCORD FREIN PLAT 8X1/2-20UNF	8	1/2 - 20UNF		0.009
043518	RACCORD FREIN EVASE 8XM14X100	8	M14X100		0.012
043519	RACCORD FREIN PLAT 8XM14X150	8	M14X150		0.016
043575	RACCORD FREIN EVASE 6X7/16-20UNF	6	7/16620UNF		0.009

Vis de conduite de frein



Vis de conduite de frein

Utilisation : Freinage hydraulique

Matière: acier

Type: Système P5

Code	Référence	D1	D2	D3	Poids
030284	RACCORD FREIN PLAT 4.76X3/8-24UNF	4.76	3/8" - 24UNF		0.008
030300	RACCORD FREIN PLAT 4.76XM10X100COURT	4.76	M10X100		0.007
030301	RACCORD FREIN PLAT 4.76XM10X125 C	4.76	M10X125		0.007
043499	RACCORD FREIN PLAT 4.76XM12X100	4.76	M12X100		0.007
043508	RACCORD FREIN PLAT 4.76XM10X125 L	4.76	M10X125		0.007
030331	RACCORD FREIN PLAT 4.76XM10X125	4.76	M10X125		0.01
043502	RACCORD FREIN PLAT 4.76X3/8-24UNF C	4.76	3/8" - 24UNF		0.007
043503	RACCORD FREIN PLAT 4.76X3/8-24UNF L	4.76	3/8" - 24UNF		0.007
043504	RACCORD FREIN PLAT 4.76X7/16-20UNF	4.76	7/16 - 20UNF		0.012
043521	RACCORD FREIN PLAT 6.35XM12X100	6.35	M12X100		0.012
CITROEN					
043500	RACCORD FREIN PLAT 3.5XM8X125 CITROE	3.5	M8X125		0.01
043501	RACCORD FREIN PLAT 4.5XM9X125 CITROE	4.5	M9X125		0.01
043522	RACCORD FREIN PLAT 6.35XM12X125 CITR	6.35	M12X125		0.01

Ecrou frein évase et plat

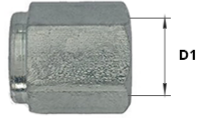

FORME E

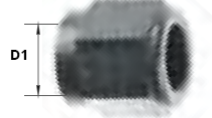

FORME F

Ecrou frein évase et plat

Utilisation : freinage hydraulique

Matière: acier

Type: Système P5

Code	Référence	D1	D2	D3	Poids
FORME E					
078099	ECROU FREIN EVASE 4.76XM10X100	4,76	M10X100		0.011
030311	ECROU FREIN EVASE 4.76XM12X100	4,76	M12X100		0
077578	ECROU FREIN EVASE 6XM12X100	6	M12X100		0
030312	ECROU FREIN EVASE 4.76X3/8-24UNF	4,76	3/8-24UNF		0
102382	ECROU FREIN EVASE 6.35X7/16-20UNF	6,35	7/16-20UNF		0
FORME F					
030314	ECROU FREIN PLAT 4,76XM10X100	4,76	M10X100		0

Raccord frein forme E et F

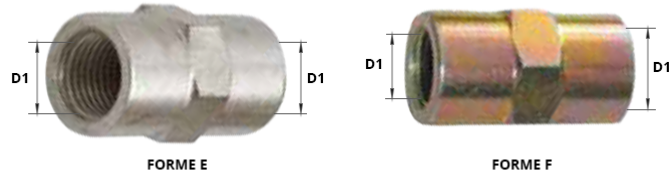

Raccord frein forme E et F

Utilisation : freinage hydraulique

Matière: acier

Type: Système P5

Code	Référence	D1	D2	D3	Poids
FORME E					
030315	MANCHON FREIN FORME E M10X100	M10X100			0.018
030317	MANCHON FREIN FORME E 7/16-24UNF	7/16" - 24UNF			0
030318	MANCHON FREIN FORME E 1/2-20UNF	1/2" - 20UNF			0
FORME F					
030319	MANCHON FREIN FORME F M10X100	M10X100			0.021
030320	MANCHON FREIN FORME F M14X150	M14X150			0
030321	MANCHON FREIN FORME F 3/8-24UNF	3/8 - 24UNF			0

Te frein femelle



Te frein femelle

Utilisation : Freinage hydraulique

Matière: laiton

Type: Système P5

Code	Référence	D1	D2	D3	Poids
030323	TE FREIN FEMELLE M10X100	M10X100			0.08
030324	TE FREIN FEMELLE M12X100	M12X100			0.08
030325	TE FREIN FEMELLE 3/8-24UNF	3/8 - 24UNF			0

Croix frein femelle



Croix frein femelle

Utilisation : Freinage hydraulique

Matière: laiton

Type: Système P5

Code	Référence	D1	D2	D3	Poids
030326	CROIX FREIN FEMELLE M10X100	M10x100			0.036
030327	CROIX FREIN FEMELLE 3/8-24UNF	3/8" - 24UNF			0

Vis de purge frein



Vis de purge frein

Utilisation : freinage hydraulique
Matière: acier

Code	Référence	D1	D2	D3	Poids
030329	VIS DE PURGE FREIN 3/8-24UNF	3/8 - 24UNF			0.01
030328	VIS DE PURGE FREIN 1/4-28UNF	1/4" - 28UNF			0.004
030330	VIS DE PURGE FREIN M10X100	M10X100			0.009

4- ACCESSOIRES POIDS LOURD



Embout a oreilles - prise de pression 16x150



Embout a oreilles - prise de pression 16x150

Matière: laiton
Type: Système P5

Code	Référence	D1	D2	D3	Poids
RA301105	RPF D05XPPF16X150	D5	16X150		0
RA301101	RPF D06XPPF16X150	D6	16X150		0
RA301102	RPF D08XPPF16X150	D8	16X150		0

Pistolet de gonflage



Pistolet de gonflage

Utilisation : freinage hydraulique

Matière : poignée en aluminium

Type : Système P5

Code	Référence	D1	D2	D3	Poids
009610	PISTOLET DE GONFLAGE STANDART				0
030560	PISTOLET DE GONFLAGE JUMELE				0
030561	PISTOLET DE GONFLAGE GARAGE				0

CONTACT

CIHAL FORBACH : TECHNOPOLE
FORBACH SUD 113 RUE ROBERT
BUNSEN 57460 - BEHREN LÈS
FORBACH, FRANCE

CIHAL ALSACE : 22 RUE HANNAH
ARENDT 67200 STRASBOURG,
FRANCE

PJHY : 1 ALL. DES BONNETONS
54425 - PULNOY FRANCE

POUR TOUTE DEMANDE OU
INFORMATION COMPLÉMENTAIRE,
VEUILLEZ NOUS CONTACTER À
L'ADRESSE MAIL SUIVANTE :
MAGASIN@CIHAL.FR

